

# DATA SHEET

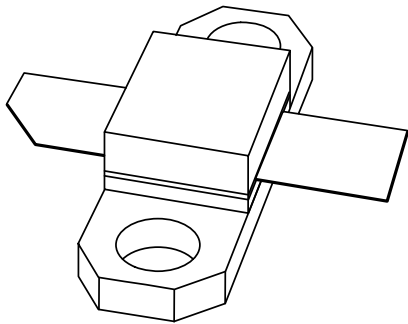

## **BLF1822-10** UHF power LDMOS transistor

Product specification  
Supersedes data of 2002 Mar 12

2003 Feb 10

## UHF power LDMOS transistor

## BLF1822-10

## FEATURES

- Typical 2-tone performance at a supply voltage of 26 V and  $I_{DQ}$  of 85 mA:
  - Output power = 10 W (PEP)
  - Gain = 18.5 dB at 900 MHz, 13.5 dB at 2200 MHz
  - Efficiency = 39% at 900 MHz, 34% at 2200 MHz
  - $d_{im} = -31$  dBc at 900 MHz,  $-28$  dBc at 2200 MHz
- Easy power control
- Excellent ruggedness
- High power gain
- Excellent thermal stability
- Designed for broadband operation (HF to 2200 MHz)
- No internal matching for broadband operation.

## APPLICATIONS

- RF power amplifiers for GSM, EDGE, CDMA and W-CDMA base stations and multicarrier applications in the HF to 2200 MHz frequency range
- Broadcast drivers.

## DESCRIPTION

10 W LDMOS power transistor for base station applications at frequencies from HF to 2200 MHz.

## QUICK REFERENCE DATA

RF performance at  $T_h = 25$  °C in a common source test circuit.

MODE OF OPERATION	f (MHz)	$V_{DS}$ (V)	$I_{DQ}$ (mA)	$P_L$ (W)	$G_p$ (dB)	$\eta_D$ (%)	$d_{im}$ (dBc)
CW, class-AB (2-tone)	$f_1 = 2200; f_2 = 2200.1$	26	85	10 (PEP)	$>11$ ; typ. 13.5	$>30$ ; typ. 34	$\leq -26$ ; typ. $-28$
	$f_1 = 960; f_2 = 960.1$	26	85	10 (PEP)	typ. 18.5	typ. 39	typ. $-33$

## PINNING - SOT467C

PIN	DESCRIPTION
1	drain
2	gate
3	source, connected to flange

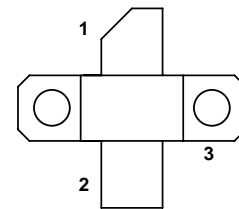

Top view MBK584

Fig.1 Simplified outline.

## CAUTION

This product is supplied in anti-static packing to prevent damage caused by electrostatic discharge during transport and handling. For further information, refer to Philips specs.: SNW-EQ-608, SNW-FQ-302A and SNW-FQ-302B.

## UHF power LDMOS transistor

BLF1822-10

**LIMITING VALUES**

In accordance with the Absolute Maximum Rating System (IEC 60134).

SYMBOL	PARAMETER	MIN.	MAX.	UNIT
$V_{DS}$	drain-source voltage	–	65	V
$V_{GS}$	gate-source voltage	–	$\pm 15$	V
$I_D$	drain current (DC)	–	2.2	A
$T_{stg}$	storage temperature	–65	+150	°C
$T_j$	junction temperature	–	200	°C

**THERMAL CHARACTERISTICS**

SYMBOL	PARAMETER	CONDITIONS	VALUE	UNIT
$R_{th\ j-mb}$	thermal resistance from junction to mounting base	$T_{mb} = 25\text{ °C}$ ; note 1	5	K/W
$R_{th\ mb-h}$	thermal resistance from mounting base to heatsink		0.5	K/W

**Note**

1. Thermal resistance is determined under RF operating conditions.

**CHARACTERISTICS** $T_j = 25\text{ °C}$  unless otherwise specified.

SYMBOL	PARAMETER	CONDITIONS	MIN.	TYP.	MAX.	UNIT
$V_{(BR)DSS}$	drain-source breakdown voltage	$V_{GS} = 0$ ; $I_D = 0.2\text{ mA}$	65	–	–	V
$V_{GSth}$	gate-source threshold voltage	$V_{DS} = 10\text{ V}$ ; $I_D = 20\text{ mA}$	4	–	5	V
$I_{DSS}$	drain-source leakage current	$V_{GS} = 0$ ; $V_{DS} = 26\text{ V}$	–	–	1.5	$\mu\text{A}$
$I_{DSX}$	on-state drain current	$V_{GS} = V_{GSth} + 9\text{ V}$ ; $V_{DS} = 10\text{ V}$	2.8	–	–	A
$I_{GSS}$	gate leakage current	$V_{GS} = \pm 15\text{ V}$ ; $V_{DS} = 0$	–	–	40	nA
$g_{fs}$	forward transconductance	$V_{DS} = 10\text{ V}$ ; $I_D = 0.75\text{ A}$	–	0.5	–	S
$R_{DSon}$	drain-source on-state resistance	$V_{GS} = 10\text{ V}$ ; $I_D = 0.75\text{ A}$	–	1.2	–	$\Omega$
$C_{is}$	input capacitance	$V_{GS} = 0$ ; $V_{DS} = 26\text{ V}$ ; $f = 1\text{ MHz}$	–	13	–	pF
$C_{os}$	output capacitance	$V_{GS} = 0$ ; $V_{DS} = 26\text{ V}$ ; $f = 1\text{ MHz}$	–	11	–	pF
$C_{rs}$	feedback capacitance	$V_{GS} = 0$ ; $V_{DS} = 26\text{ V}$ ; $f = 1\text{ MHz}$	–	0.5	–	pF

UHF power LDMOS transistor

BLF1822-10

**APPLICATION INFORMATION 2.2 GHz**

RF performance in a common source class-AB circuit.  $T_h = 25\text{ }^\circ\text{C}$ ;  $R_{th\text{ mb-h}} = 0.4\text{ K/W}$ ; unless otherwise specified.

MODE OF OPERATION	f (MHz)	V <sub>DS</sub> (V)	I <sub>DQ</sub> (mA)	P <sub>L</sub> (W)	G <sub>p</sub> (dB)	η <sub>D</sub> (%)	d <sub>im</sub> (dBc)
CW, class-AB (2-tone)	f <sub>1</sub> = 2200; f <sub>2</sub> = 2200.1	26	85	10 (PEP)	>11	>30	≤-26

**Ruggedness in class-AB operation**

The BLF1822-10 is capable of withstanding a load mismatch corresponding to VSWR = 10 : 1 through all phases under the following conditions: V<sub>DS</sub> = 26 V; f = 2200 MHz at rated load power.

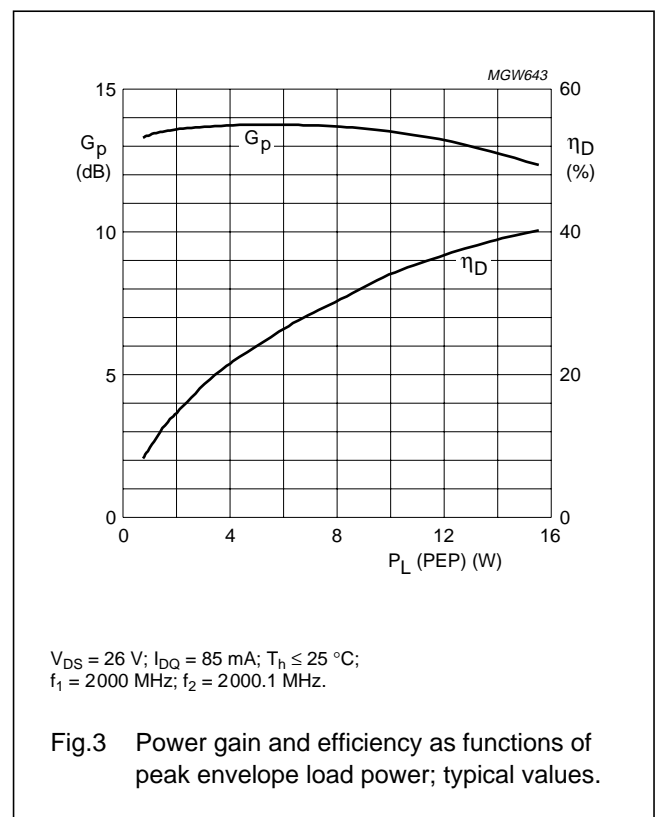
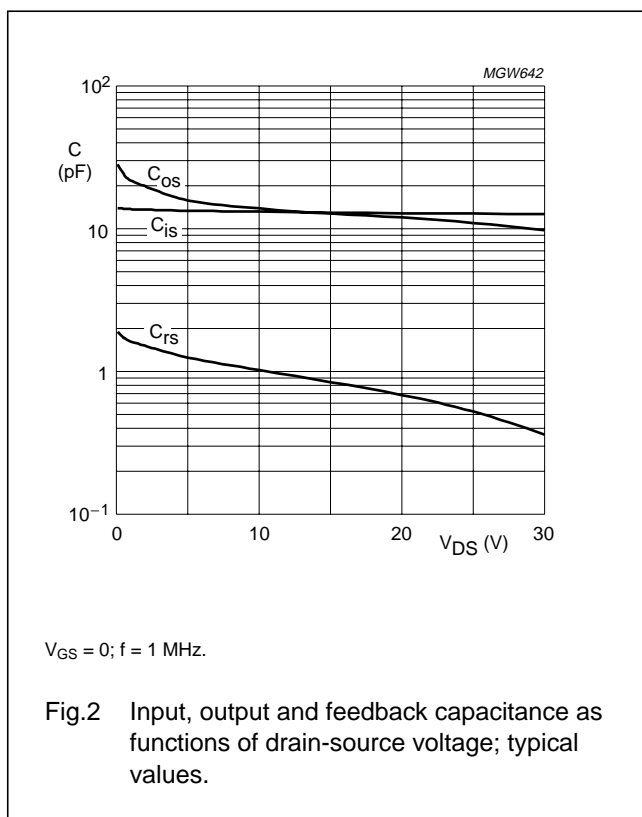

UHF power LDMOS transistor

BLF1822-10

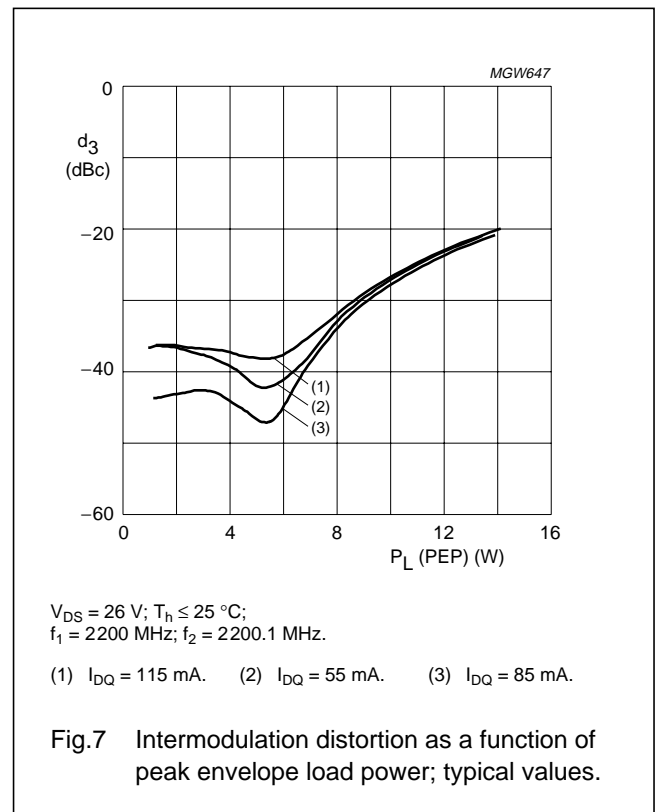
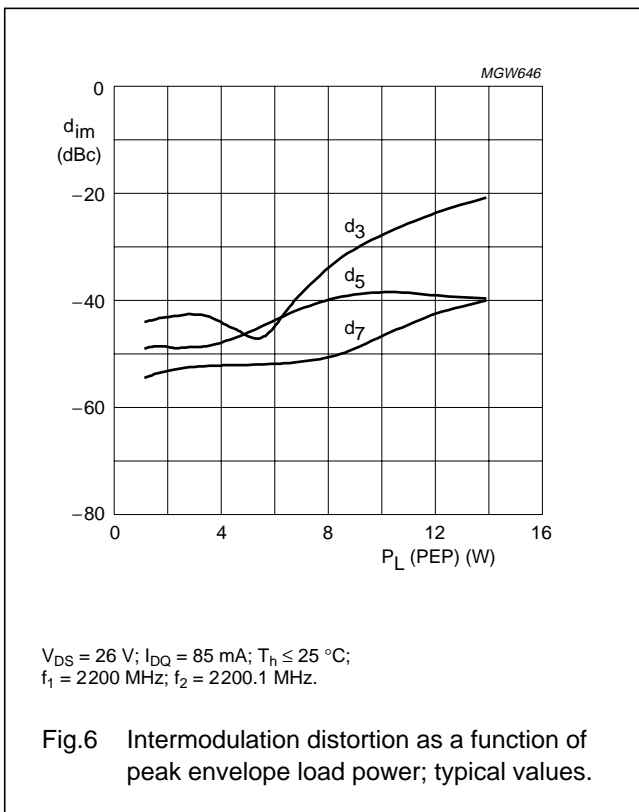
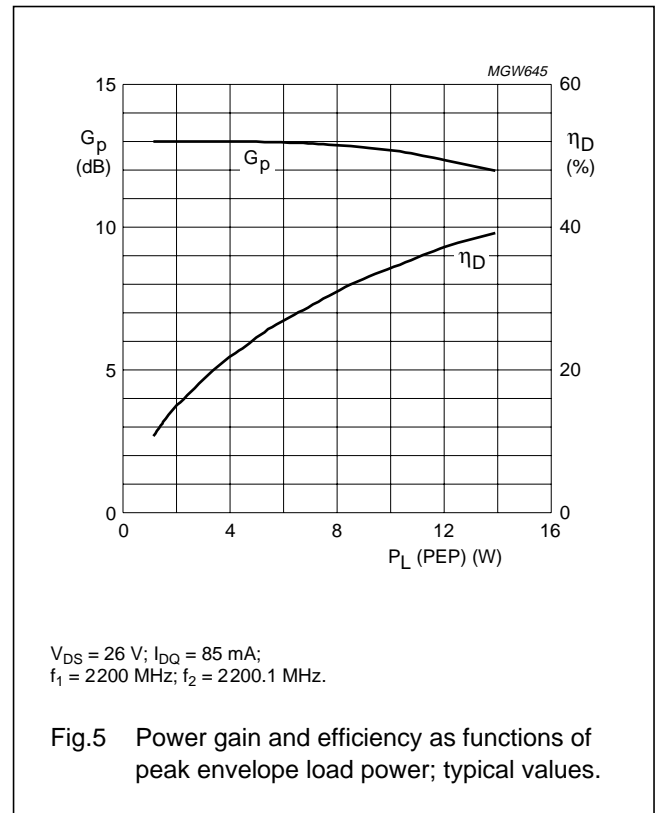
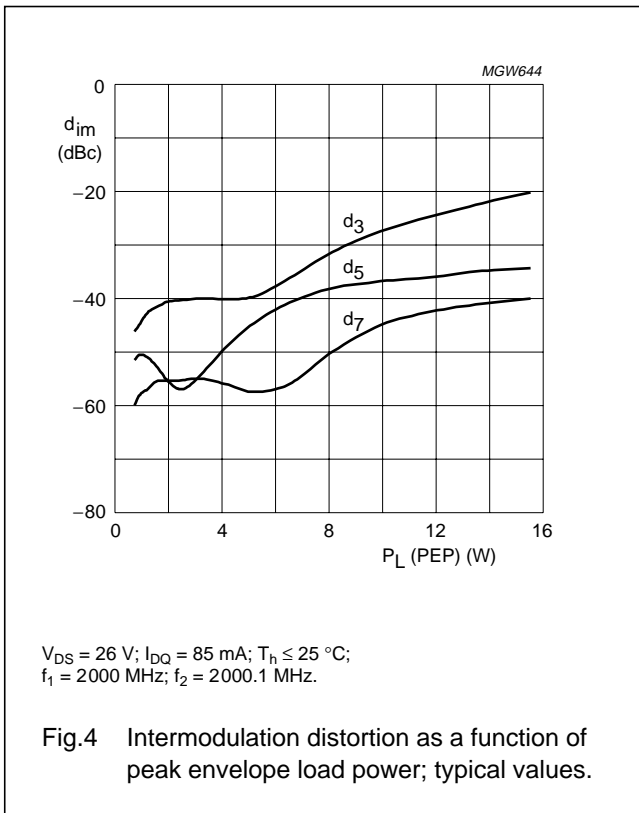

UHF power LDMOS transistor

BLF1822-10

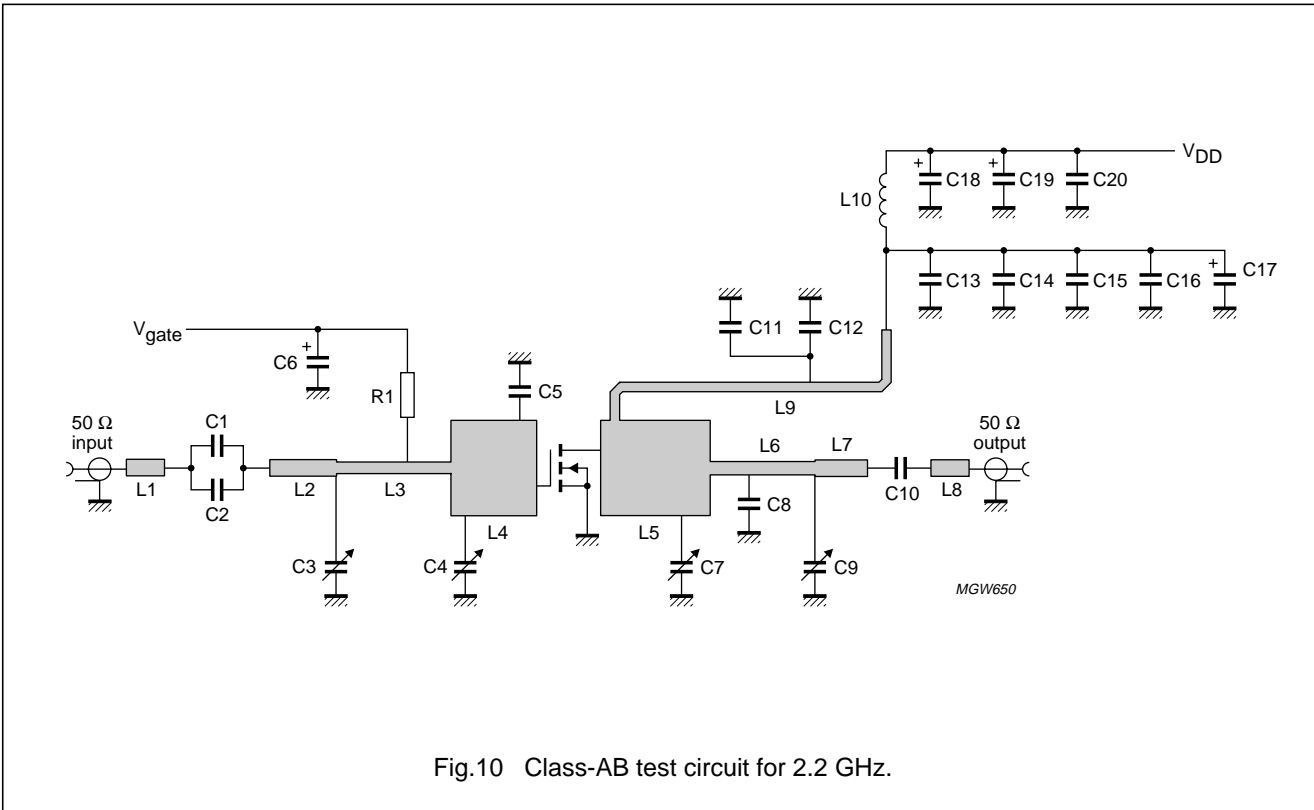
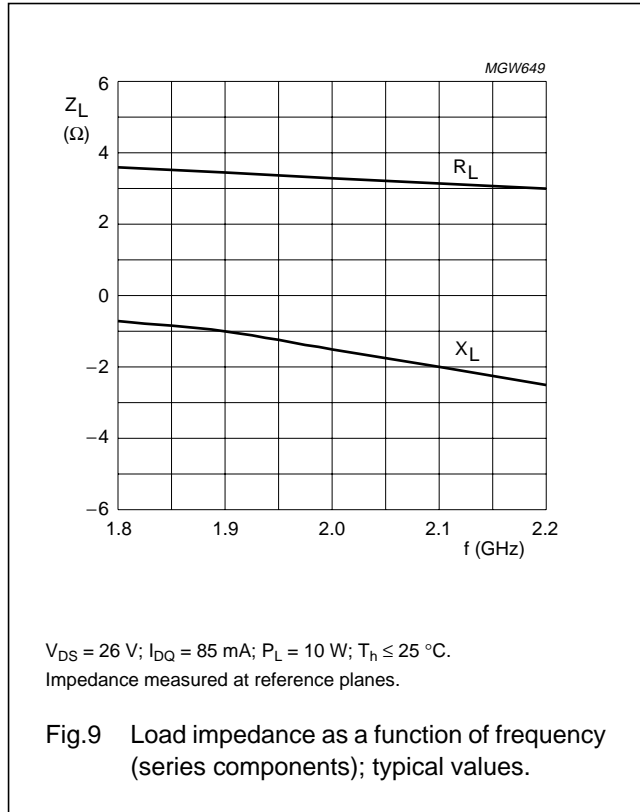
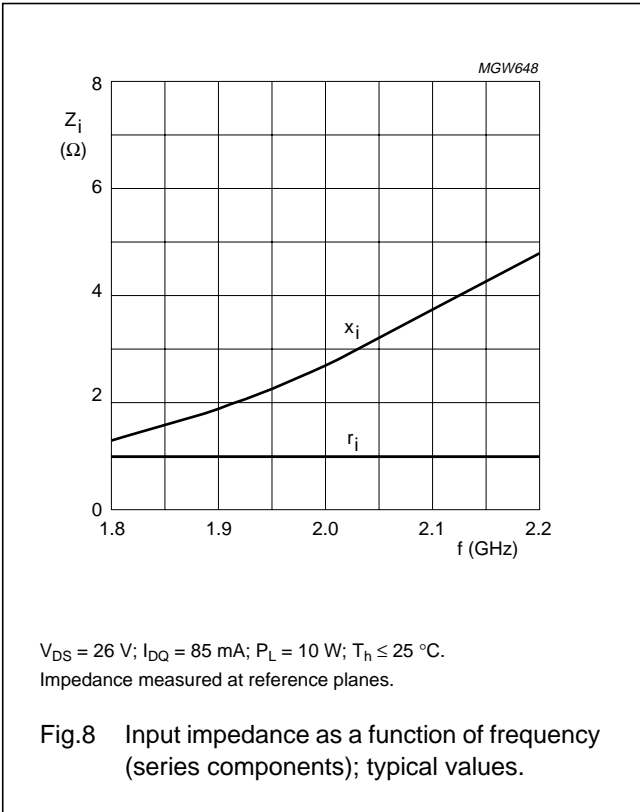

## UHF power LDMOS transistor

BLF1822-10

## List of components (see Figs 10 and 11)

COMPONENT	DESCRIPTION	VALUE	DIMENSIONS	CATALOGUE NO.
C1, C2, C10, C11	multilayer ceramic chip capacitor; note 1	6.8 pF		
C3, C4, C7, C9	Tekelec variable capacitor; type 37271	0.6 to 4.5 pF		
C5	multilayer ceramic chip capacitor; note 1	2.4 pF		
C6, C18	tantalum SMD capacitor	10 $\mu$ F; 35 V		
C8	multilayer ceramic chip capacitor; note 1	1.5 pF		
C12, C20	multilayer ceramic chip capacitor; note 2	1 nF		
C13	multilayer ceramic chip capacitor; note 1	10 pF		
C14	multilayer ceramic chip capacitor; note 1	51 pF		
C15	multilayer ceramic chip capacitor; note 1	120 pF		
C16	multilayer ceramic chip capacitor	100 nF		2222 581 16641
C17	electrolytic capacitor	47 $\mu$ F; 35 V		2222 036 90094
C19	electrolytic capacitor	100 $\mu$ F; 63 V		2222 037 58101
L1, L8	stripline; note 3	50 $\Omega$	4 $\times$ 1.5 mm	
L2	stripline; note 3	50 $\Omega$	7 $\times$ 1.5 mm	
L3	stripline; note 3	58.1 $\Omega$	12 $\times$ 1.2 mm	
L4	stripline; note 3	11.3 $\Omega$	9 $\times$ 10 mm	
L5	stripline; note 3	11.3 $\Omega$	11.5 $\times$ 10 mm	
L6	stripline; note 3	52.8 $\Omega$	11 $\times$ 1.4 mm	
L7	stripline; note 3	50 $\Omega$	5.5 $\times$ 1.5 mm	
L9	stripline; note 3	64.7 $\Omega$	38 $\times$ 1 mm	
L10	2 turns enamelled 0.5 mm copper wire		int. dia. = 3 mm; length = 3 mm	
R1	metal film resistor	390 $\Omega$ ; 0.6 W		2322 156 11009

## Notes

1. American Technical Ceramics type 100A or capacitor of same quality.
2. American Technical Ceramics type 100B or capacitor of same quality.
3. The striplines are on a double copper-clad printed-circuit board with Rogers 5880 dielectric ( $\epsilon_r = 2.2$ ); thickness 0.51 mm.

UHF power LDMOS transistor

BLF1822-10

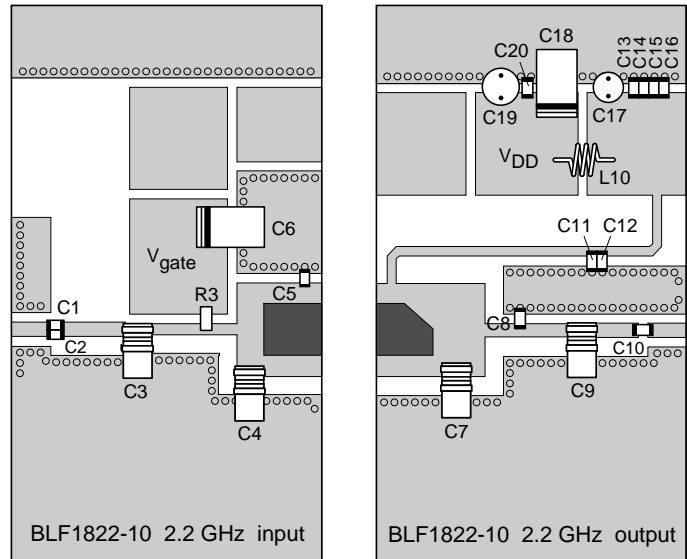

Dimensions in mm.

The components are situated on one side of the copper-clad printed-circuit board with Teflon dielectric ( $\epsilon_r = 2.2$ ), thickness 0.51 mm. The other side is unetched and serves as a ground plane.

Fig.11 Component layout for 2.2 GHz class-AB test circuit.



UHF power LDMOS transistor

BLF1822-10

**APPLICATION INFORMATION 960 MHz**

RF performance in a common source class-AB circuit.  $T_h = 25\text{ }^\circ\text{C}$ ;  $R_{th\text{ mb-h}} = 0.4\text{ K/W}$ ; unless otherwise specified.

MODE OF OPERATION	f (MHz)	V <sub>DS</sub> (V)	I <sub>DQ</sub> (mA)	P <sub>L</sub> (W)	G <sub>p</sub> (dB)	η <sub>D</sub> (%)	d <sub>im</sub> (dBc)
CW, class-AB (2-tone)	f <sub>1</sub> = 960; f <sub>2</sub> = 960.1	26	85	10 (PEP)	typ. 18.5	typ. 39	typ. -33

**Ruggedness in class-AB operation**

The BLF1822-10 is capable of withstanding a load mismatch corresponding to VSWR = 10 : 1 through all phases under the following conditions: V<sub>DS</sub> = 26 V; f = 960 MHz at rated load power.

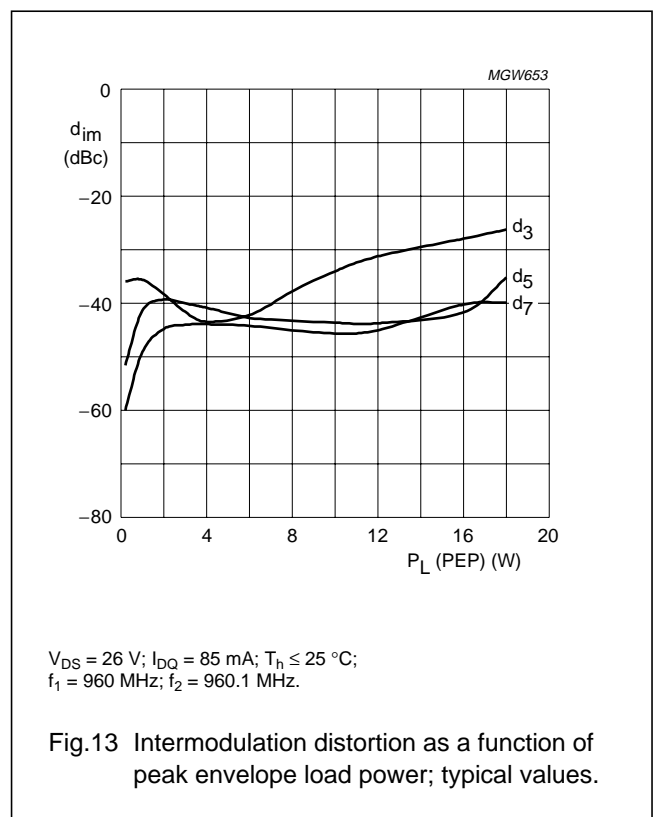
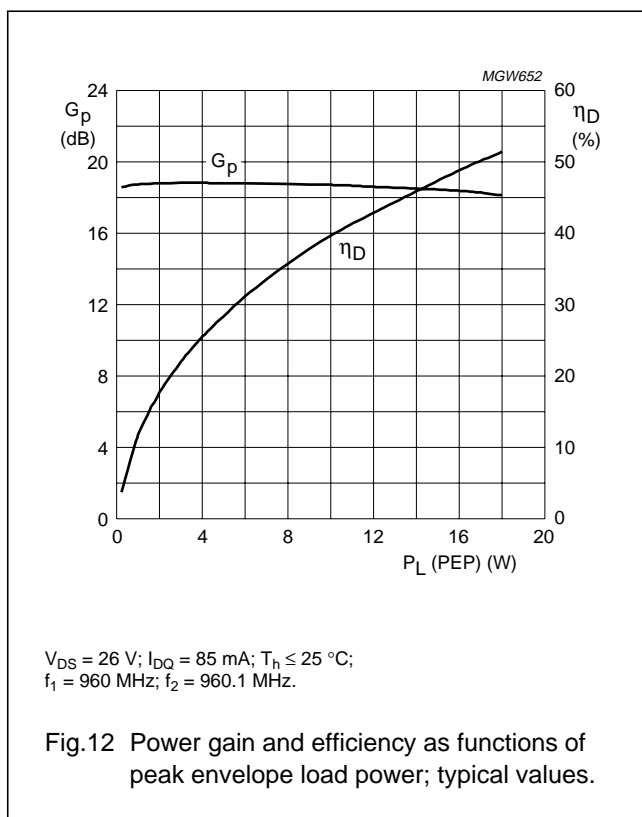

UHF power LDMOS transistor

BLF1822-10

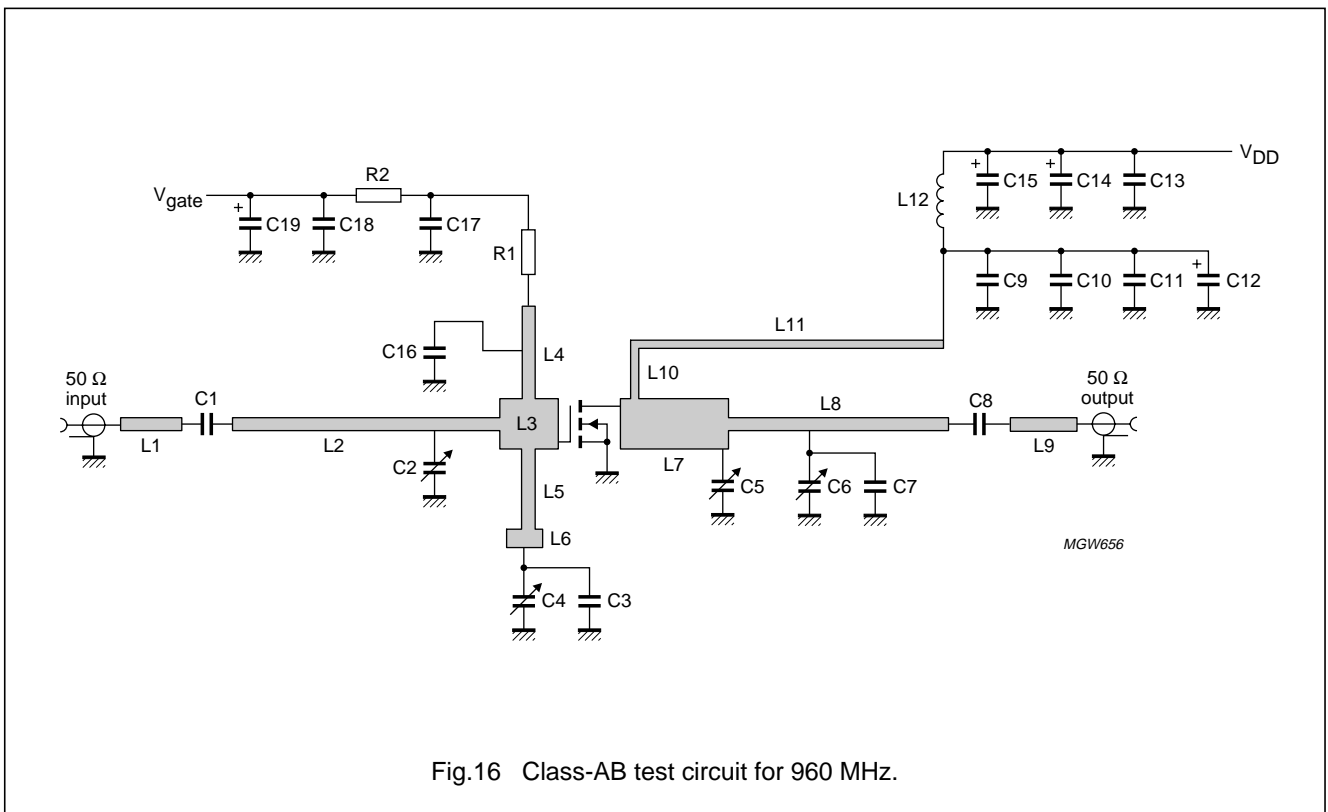
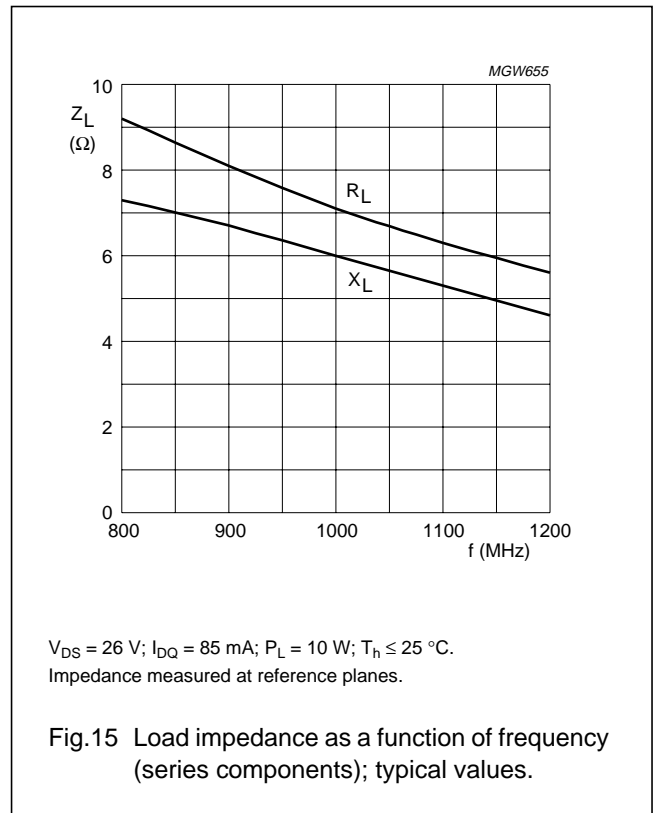
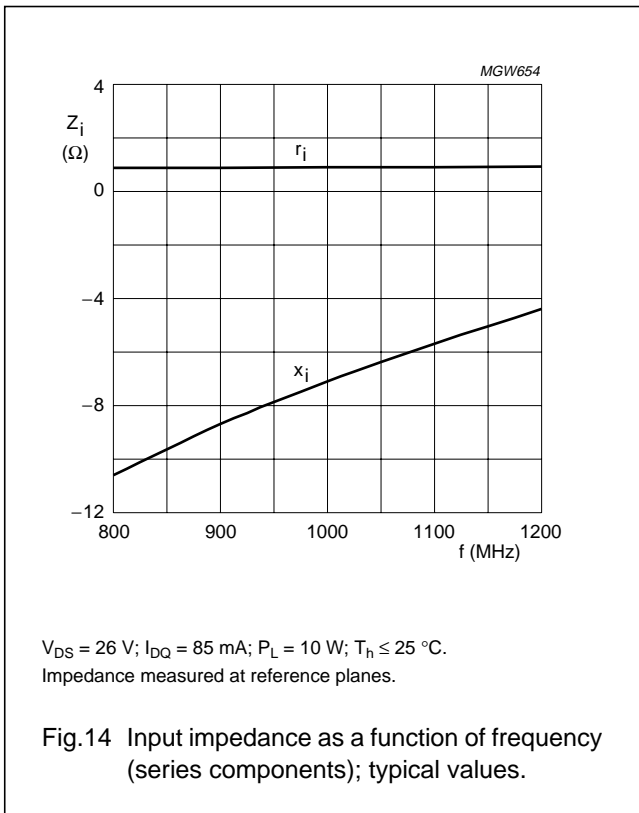

## UHF power LDMOS transistor

BLF1822-10

## List of components (see Figs 16 and 17)

COMPONENT	DESCRIPTION	VALUE	DIMENSIONS	CATALOGUE NO.
C1	multilayer ceramic chip capacitor; note 1	82 pF		
C2, C6	Tekelec variable capacitor; type 27291	0.8 to 8 pF		
C3	multilayer ceramic chip capacitor; note 1	0.3 pF		
C4, C5	Tekelec variable capacitor; type 27271	0.6 to 4.5 pF		
C7	multilayer ceramic chip capacitor; note 1	2.1 pF		
C8	multilayer ceramic chip capacitor; note 2	56 pF		
C19, C14, C19	multilayer ceramic chip capacitor	100 pF	size 0805	
C10, C17	multilayer ceramic chip capacitor	1 nF	size 0805	
C12, C14, C19	tantalum SMD capacitor	6.8 $\mu$ F		
C13	multilayer ceramic chip capacitor	100 nF		2222 581 16641
C15	electrolytic capacitor	100 $\mu$ F; 63 V		2222 037 58101
C16	multilayer ceramic chip capacitor; note 1	68 pF		
L1	stripline; note 3	50 $\Omega$	7.5 $\times$ 1.57 mm	
L2	stripline; note 3	50 $\Omega$	34.5 $\times$ 1.57 mm	
L3	stripline; note 3	19.2 $\Omega$	7 $\times$ 6 mm	
L4	stripline; note 3	50 $\Omega$	11 $\times$ 1.57 mm	
L5	stripline; note 3	50 $\Omega$	9.5 $\times$ 1.57 mm	
L6	stripline; note 3	24.5 $\Omega$	2.2 $\times$ 4.4 mm	
L7	stripline; note 3	19.2 $\Omega$	13 $\times$ 6 mm	
L8	stripline; note 3	50 $\Omega$	27.5 $\times$ 1.57 mm	
L9	stripline; note 3	50 $\Omega$	8 $\times$ 1.57 mm	
L10	stripline; note 2	64.4 $\Omega$	6.4 $\times$ 1 mm	
L11	stripline; note 3	64.4 $\Omega$	38 $\times$ 1 mm	
L12	3 turns enamelled 0.5 mm copper wire		int. dia. = 4 mm length = 5 mm	
R1	resistor	51 $\Omega$ , 0.25 W	size 1206	
R2	resistor	1 k $\Omega$ , 0.25 W	size 1206	

## Notes

1. American Technical Ceramics type 500A or capacitor of same quality.
2. American Technical Ceramics type 100B or capacitor of same quality.
3. The striplines are on a double copper-clad printed-circuit board with Rogers 4350 dielectric ( $\epsilon_r = 3.81$ ); thickness 0.76 mm.

UHF power LDMOS transistor

BLF1822-10

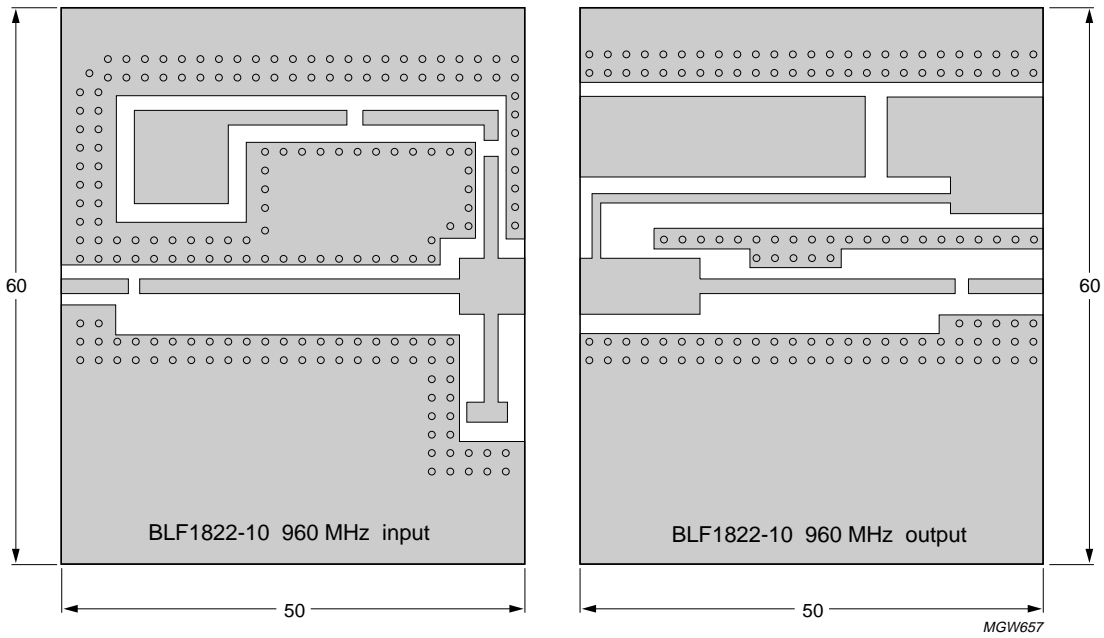
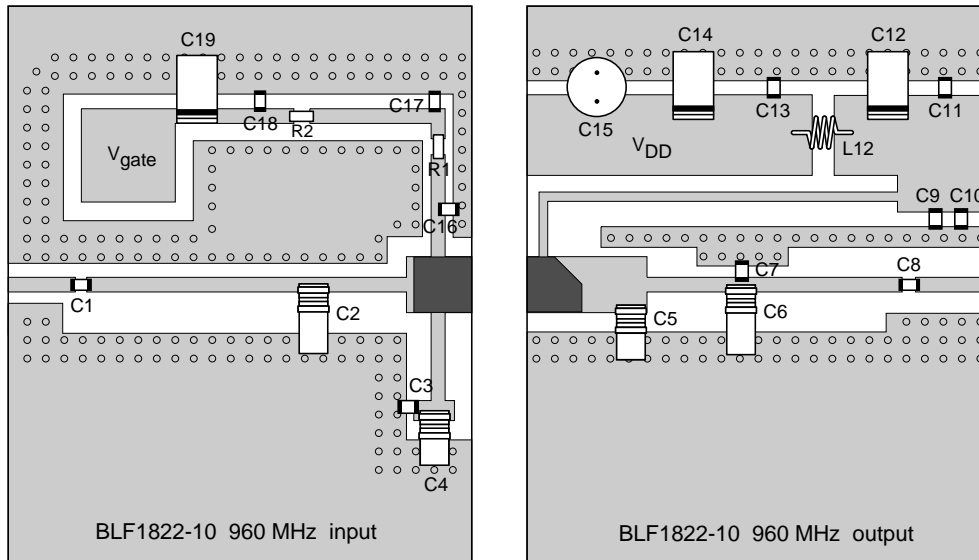

Dimensions in mm.

The components are situated on one side of the copper-clad printed-circuit board with Rogers 4350 dielectric ( $\epsilon_r = 3.81$ ), thickness 0.76 mm. The other side is unetched and serves as a ground plane.

Fig.17 Component layout for 960 MHz class-AB test circuit.

MGW657

UHF power LDMOS transistor

BLF1822-10

PACKAGE OUTLINE

Flanged LDMOST ceramic package; 2 mounting holes; 2 leads

SOT467C

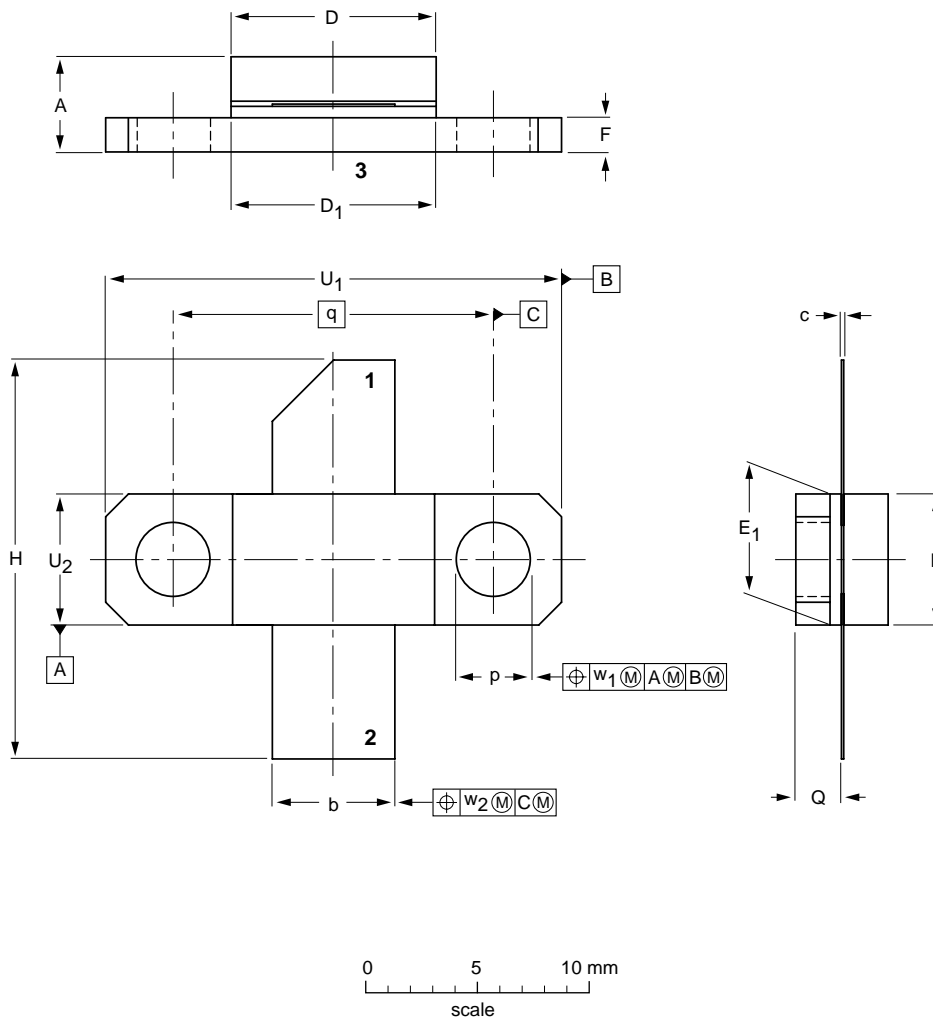

DIMENSIONS (millimetre dimensions are derived from the original inch dimensions)

UNIT	A	b	c	D	D <sub>1</sub>	E	E <sub>1</sub>	F	H	p	Q	q	U <sub>1</sub>	U <sub>2</sub>	w <sub>1</sub>	w <sub>2</sub>
mm	4.67 3.94	5.59 5.33	0.15 0.10	9.25 9.04	9.27 9.02	5.92 5.77	5.97 5.72	1.65 1.40	18.54 17.02	3.43 3.18	2.21 1.96	14.27	20.45 20.19	5.97 5.72	0.25	0.51
inch	0.184 0.155	0.220 0.210	0.006 0.004	0.364 0.356	0.365 0.355	0.233 0.227	0.235 0.225	0.065 0.055	0.73 0.67	0.135 0.125	0.087 0.077	0.562	0.805 0.795	0.235 0.225	0.010	0.020

OUTLINE VERSION	REFERENCES				EUROPEAN PROJECTION	ISSUE DATE
	IEC	JEDEC	EIAJ			
SOT467C						99-12-06 99-12-28

## UHF power LDMOS transistor

BLF1822-10

## DATA SHEET STATUS

LEVEL	DATA SHEET STATUS <sup>(1)</sup>	PRODUCT STATUS <sup>(2)(3)</sup>	DEFINITION
I	Objective data	Development	This data sheet contains data from the objective specification for product development. Philips Semiconductors reserves the right to change the specification in any manner without notice.
II	Preliminary data	Qualification	This data sheet contains data from the preliminary specification. Supplementary data will be published at a later date. Philips Semiconductors reserves the right to change the specification without notice, in order to improve the design and supply the best possible product.
III	Product data	Production	This data sheet contains data from the product specification. Philips Semiconductors reserves the right to make changes at any time in order to improve the design, manufacturing and supply. Relevant changes will be communicated via a Customer Product/Process Change Notification (CPCN).

## Notes

1. Please consult the most recently issued data sheet before initiating or completing a design.
2. The product status of the device(s) described in this data sheet may have changed since this data sheet was published. The latest information is available on the Internet at URL <http://www.semiconductors.philips.com>.
3. For data sheets describing multiple type numbers, the highest-level product status determines the data sheet status.

## DEFINITIONS

**Short-form specification** — The data in a short-form specification is extracted from a full data sheet with the same type number and title. For detailed information see the relevant data sheet or data handbook.

**Limiting values definition** — Limiting values given are in accordance with the Absolute Maximum Rating System (IEC 60134). Stress above one or more of the limiting values may cause permanent damage to the device. These are stress ratings only and operation of the device at these or at any other conditions above those given in the Characteristics sections of the specification is not implied. Exposure to limiting values for extended periods may affect device reliability.

**Application information** — Applications that are described herein for any of these products are for illustrative purposes only. Philips Semiconductors make no representation or warranty that such applications will be suitable for the specified use without further testing or modification.

## DISCLAIMERS

**Life support applications** — These products are not designed for use in life support appliances, devices, or systems where malfunction of these products can reasonably be expected to result in personal injury. Philips Semiconductors customers using or selling these products for use in such applications do so at their own risk and agree to fully indemnify Philips Semiconductors for any damages resulting from such application.

**Right to make changes** — Philips Semiconductors reserves the right to make changes in the products - including circuits, standard cells, and/or software - described or contained herein in order to improve design and/or performance. When the product is in full production (status 'Production'), relevant changes will be communicated via a Customer Product/Process Change Notification (CPCN). Philips Semiconductors assumes no responsibility or liability for the use of any of these products, conveys no licence or title under any patent, copyright, or mask work right to these products, and makes no representations or warranties that these products are free from patent, copyright, or mask work right infringement, unless otherwise specified.

UHF power LDMOS transistor

BLF1822-10

---

**NOTES**

# ***Philips Semiconductors – a worldwide company***

## **Contact information**

For additional information please visit <http://www.semiconductors.philips.com>. Fax: +31 40 27 24825

For sales offices addresses send e-mail to: [sales.addresses@www.semiconductors.philips.com](mailto:sales.addresses@www.semiconductors.philips.com).

© Koninklijke Philips Electronics N.V. 2003

SCA75

All rights are reserved. Reproduction in whole or in part is prohibited without the prior written consent of the copyright owner.

The information presented in this document does not form part of any quotation or contract, is believed to be accurate and reliable and may be changed without notice. No liability will be accepted by the publisher for any consequence of its use. Publication thereof does not convey nor imply any license under patent- or other industrial or intellectual property rights.

Printed in The Netherlands

613524/04/pp16

Date of release: 2003 Feb 10

Document order number: 9397 750 10914

*Let's make things better.*

**Philips  
Semiconductors**



**PHILIPS**